

# Effectiveness of Dynamic Voltage Restorer in Enhancing Voltage Profile in Low Voltage Electric Power Distribution Networks under Normal Mode Operation

Ogunboyo Patrick Taiwo, Remy Tiako  
Electrical, Electronic & Computer Engineering Discipline  
University of KwaZulu-Natal, Durban,  
South Africa  
[ogunboyo@ukzn.ac.za](mailto:ogunboyo@ukzn.ac.za), [Tiako@ukzn.ac.za](mailto:Tiako@ukzn.ac.za)

Innocent E. Davidson  
Dept. of Electrical Power Engineering  
Durban University of Technology,  
Durban, South Africa  
[Innocentd@dut.ac.za](mailto:Innocentd@dut.ac.za)

**Abstract**— This work addresses the compensation of power quality disturbance in electric power distribution network as a result of voltage variation and voltage unbalanced using one of the most effective power electronics based custom power controller known as Dynamic Voltage Restorer (DVR). DVR usually connected between the source voltage and the customer load. The new setup of DVR has been put forward using dqo controller and proportional integral (PI) controller method. The simulations are achieved using MATLAB/Simulink Sim Power System tool box. The simulation results attest to the effectiveness of the proposed DVR configuration in compensating the power quality problems in secondary distribution system. The simulation results runs are presented with different settings of parameter used in the model in order to help the validity of the function of DVR in enhancing the quality of power supply at customer side.

**Keywords**— *distribution system, d-q-o controller, voltage variation, voltage unbalance, power quality, Dynamic Voltage restorer, customer load.*

## I. INTRODUCTION

The most frequently seen power quality problems in secondary distribution system today is voltage unbalanced. Voltage unbalanced is the ratio of the maximum voltage deviation of phase voltages from the average phase-voltage magnitude to the average phase-voltage magnitude [1]. Similarly, in [2] voltage unbalanced is defined as the ratio of the difference between the highest and the lowest phase-voltage magnitude to the average phase-voltage magnitude. Also in related to electric power quality [3] define voltage unbalanced as the ratio of the negative-sequence voltage component to the positive-sequence voltage component and the ratio of the zero-sequence voltage component to the positive-sequence voltage component respectively.

The quality of electrical power which is given to the end users can be assessed or estimated in terms of constant voltage magnitude that is balanced phases, zero voltage variation, constant power factor, constant frequency, zero voltage swells or sags and finally a complete absence of power interruptions and ability to withstand faults and to equanimity fast. The use of custom power based electronic controller in the electric power distribution network to provide high quality electrical power to the end users have become high standing importance of the electricity industry in the deregulated power system world.

Many of power custom devices are available in present days to solve the power quality disturbances in low voltage distribution network. This includes distribution static synchronous compensators (DSTATCOM), distribution series capacitors and power factor corrector (PFC), static Var compensator (SVC), uninterruptible power supplies (UPS), solid state transfer switches (SSTS) and a lot of more

Various techniques can be employed to stop component undesirable operation as a result of voltage unbalance in electric power distribution system. The most efficient, easy to maintain, fast response and cheapest method is the use of DVR to compensate voltage unbalance disturbance in low voltage electric power distribution network. DVR is a series connected voltage controller which is connected to the electric distribution network with the help of transformer [4]

A lot of researchers in the field of power quality show that dynamic voltage restorer has been effectively used to find a solution to the power quality problems in distribution network. [5, 6] proposed the flexible controllers with the use of newly available power electronics components, are developed for custom power applications. A two-pulse VSC based on PWM control scheme has been carried out to control electronic values in DVR and DSTATCOM [7, 8]. DVR has been effectively employed to suppress harmonic as presented by [9]. To decrease down streams fault current [10] and the problems of voltage dips and swell was addressed by [11, 12].

This paper investigates how to mitigate voltage unbalanced and voltage variation in a typical radial low voltage electric power distribution network. This is carried by using a DVR a well know electronic based custom power device.

## THE PROPOSED METHODOLOGY

### II. DYNAMIC VOLTAGE RESTORER

A dynamic voltage restorer (DVR) is a solid state custom power device which is connected in series to the load voltage for the purpose of injecting a controlled voltage to the electric distribution network. The most vital role of a DVR is to mitigate voltage unbalanced and voltage variation, except it can likewise carry out the tasks such as compensate voltage swells and sags, fault current limitation, harmonics elimination and reduction of voltage transients [13, 4]. DVR is a voltage source converter that injects a dynamically controlled voltage in series to supply voltage via three single phase boosting transformer for improving the load voltage.

The schematic diagram of DVR is shown in Fig 1. It consist of three important parts: measuring unit, control unit and power unit.

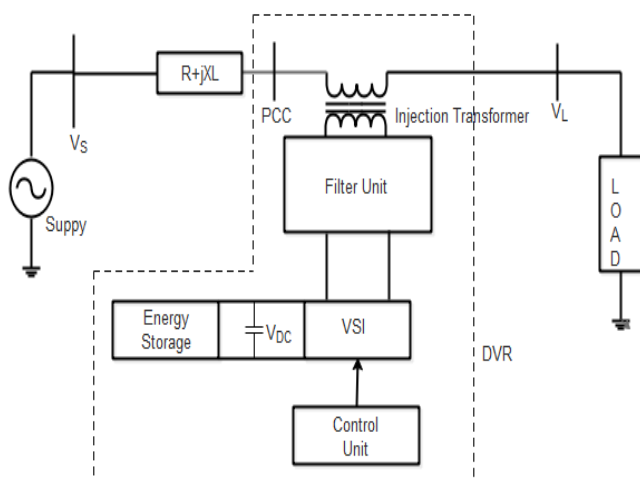

Fig.1. Schematic diagram of DVR

The measuring unit gives voltage measurement in the system. The output voltage enters the control unit of the distribution system. The control unit detects the voltage imbalance in the system by calculating the required to be supplied to the electric power distribution network to keep the customer side voltage in nominal standards. The DVR power circuit comprises of a voltage source inverter provided with a DC energy storage, a LC filter and a series boosting injection transformer.

The essential components of DVR are used for the following purposes: injection transformer is series connected to the electric distribution line. It helps to inject the appropriate voltage to the source voltage when voltage unbalance and voltage variation occur; voltage source inverter is used to produce a sinusoidal voltage with the needed magnitude, phase and frequency; energy storage unit supply the needed real

power during disturbance with the help of a simple capacitor or a battery; LC filter is used to reduce the unwanted harmonic components generated by the IGBT inverter to allowable limit; and a bypass switch is used to separate the DVR from the network in the event of excessive currents.

The fundamental operation of DVR is to supply the needed voltage to the supply voltage for the purpose of mitigating voltage unbalanced and variation on the load side. The control circuit compares set voltage and load voltage, the significant change between the signals is taken as a DVR mitigating voltage. The compensating voltage is a digital input for a (PWM) generator to systematically control the voltage source inverter. The voltage source inverter changes the DC stored energy to alternating voltage which is to be injected to the source voltage through a boosting transformer. The performance of DVR compensating result rely on the quantity of stored energy in the DC storage compartment.

### III. DVR CONTROL STRATEGY

The DVR monitors the terminal voltage, the measured terminal voltage is changed to its conforming  $dq$  components. The  $dq$  components of the terminal voltage are compared with the reference voltage. In the event of unbalanced voltage and voltage sag in the system is sensed, an error signal will be generated due to the difference between the terminal voltage measured and the reference voltage values then the controller will start the process of injecting missing voltage to the network. The error signal will force the proportional and integral controller which controls the system depending on the actuating error signal. The generated out signal from the proportional and integral controller is converted back to three-phase  $rby$  voltage before it is sent to the pulse width modulation (PWM) generator. The PWM control method generates pulses to trigger the  $PWM$  inverter with the desired firing sequence. Similarly, it generates a three-phase 50 cycles per second sinusoidal voltage at the terminal of the load. A low pass filter is used to suppress the generated harmonics frequencies, in order to smoothen the output voltage going to the voltage source inverter. In this paper the  $dqo$  control algorithm is used to generate a three-phase reference voltage to the series voltage source inverter that helps to keep the terminal voltage at its nominal value. The  $dqo$  Park's transformation equation is shown in equation (5). The  $PI$  diagram is shown in Fig. 2, while the block diagram for phase-locked loop ( $PLL$ ) circuit used to generate a unit sinusoidal wave in phase with the supply voltage is shown in Fig. 3

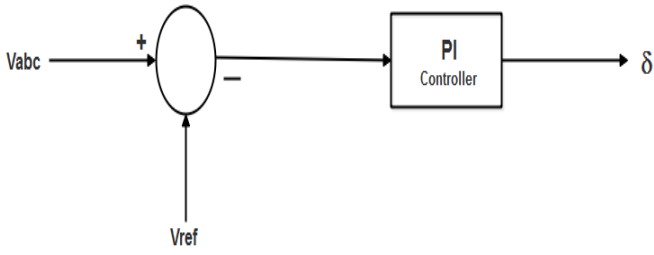

Fig. 2. Schematic diagram of PI controller

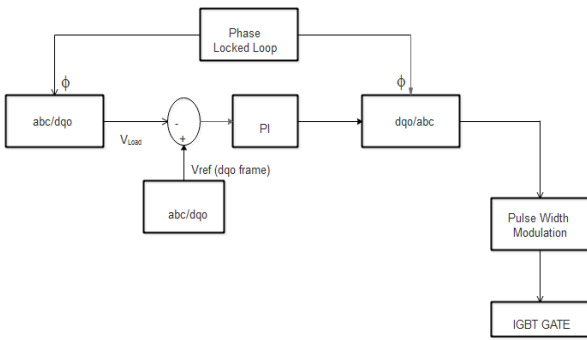

Fig. 3. DVR control scheme

$$\begin{bmatrix} V_d \\ V_q \\ V_0 \end{bmatrix} = \frac{1}{3} \begin{bmatrix} 2 \sin \omega t & 2 \sin \left( \omega t - \frac{2\pi}{3} \right) & 2 \sin \left( \omega t + \frac{2\pi}{3} \right) \\ 2 \cos \omega t & 2 \cos \left( \omega t - \frac{2\pi}{3} \right) & 2 \cos \left( \omega t + \frac{2\pi}{3} \right) \\ 1 & 1 & 1 \end{bmatrix} \begin{bmatrix} V_r \\ V_b \\ V_y \end{bmatrix} \quad (1)$$

The system load voltages are given as

$$\begin{aligned} V_r &= V_p \sin \omega t \\ V_b &= V_p \sin \left( \omega t - \frac{2\pi}{3} \right) \\ V_y &= V_p \sin \left( \omega t + \frac{2\pi}{3} \right) \end{aligned} \quad (2)$$

Where  $V_p$  and  $\omega$  are the peak amplitude and angular frequency respectively, of the network voltage at the point of coupling

The amplitude of PCC voltage is given as:

$$V_a = \sqrt{\frac{2}{3} (V_r^2 + V_b^2 + V_y^2)} \quad (3)$$

The DVR apparent power is given as:

$$\begin{aligned} S_{DVR} &= I_L V_{DVR} \\ &= I_L \sqrt{V^2_L + V^2_S - 2V_L V_S \cos(\theta_L - \theta_S)} \end{aligned} \quad (4)$$

The active power of DVR is given as:

$$P_{DVR} = I_L (V_L \cos \theta_L - V_S \cos \theta_S) \quad (5)$$

The MATLAB/Simulink model of low voltage electric power distribution network for power circuit and control circuit is shown in Fig. 4

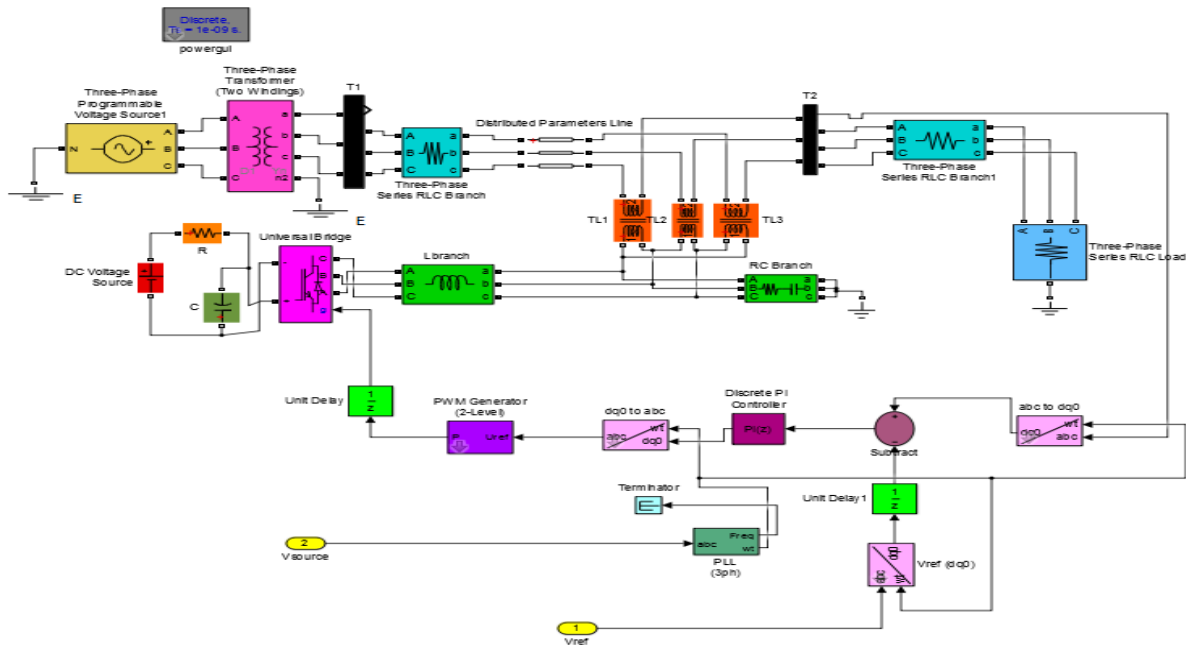

Fig. 4. proposed MATLAB/Simulink model of DVR

IV. SIMULATION RESULTS AND DISCUSSION

The performance of *DVR* is studied with the *PI* controller and *d-q-o* based algorithm. The *DVR DC* bus voltage is chosen as 400 V for the source line voltage of 415 V.

The *LV* electric distribution network presented in this model is based on the standard network parameters as tabulated in Table I. The length of the *LV* electric power distribution feeder ranges from 0.5 km to 5 km, the voltage levels and conductor type of the *LV* access network consist of 500 kVA, 415  $V_{L-L}$ , 220  $V_{L-N}$  through 11/0.415 kV, at 0.9 pf, 80 % full load transformer rating, based on all-aluminum conductors (AAC) standard.

The simulation results are taken as shown in Table I, for load conditions.

TABLE I. SYSTEM AND DVR PARAMETERS FOR 3-PHASE BALANCED AND UNBALANCED LOAD

Parameter	Value
Distribution Transformer	11/0.4 kV, 500 kVA, $\Delta/Y$ grounded.
MV Feeder	Three Phase 11 kV radial, overhead line.
LV Feeder	3-phase 4-wire, 400 V, overhead all-aluminium conductors 100 mm <sup>2</sup>
Balanced load	Phase A, B and C Load are 120 kW each at 0.9 pf 80 % transformer rating.
Unbalanced load	Red phase load is 150 kW, Blue

	phase load is 110 kW Yellow phase is 80 kW at 0.9 pf 80 % transformer rating.
Line impedance ( $\Omega$ )	$L = 1 \text{ mH}, R = 0.01 \Omega$
Line frequency (Hz)	50
Load phase voltage (V)	220
DC supply Voltage (V)	400
Injection transformer turns ratio	1:1
PI controller	Sample time=50 $\mu\text{s}$ , $K_P=0.5$ , $K_I=50$
Inverter specification	Three arms IGBT based, six pulse, sample time 50 $\mu\text{s}$ , carrier frequency 1080 Hz
Linear Transformer	5 kVA, 100/400 V
Filter inductance	7 mH
Filter capacitance	10 $\mu\text{F}$

Two cases were simulated using MATLAB/Simulink software Sim Power System tool box. The numerical data were taken from the Table 1. The cases under study can be summarized as follows:

**Case I:** A three-phase balanced load is applied at 120 kW per-phase for distribution feeder length of 0.5 km to 5 km. The voltage during this event is equal in the three-phases. The simulations were performed for without DVR and with DVR in the distribution system

**Case II:** A three-phase unbalanced load is applied at 150 kW, 110 kW and 80 kW for each phase respectively for distribution feeder length of 0.5 km to 5 km. The voltage

during this event is not equal in the three-phases. The simulations were performed for without DVR and with DVR in the distribution system.

4.1 Simulation results of 3-phase balanced load without and with DVR

The first case presented is the simulation of three-phase balanced load of radial network in the absence of DVR in the distribution system, the waveforms are as shown in Figures 5a to 11a respectively. It was noticed that at distribution length of 0.5 km the voltage reaching the electricity consumer end is 0.95 p.u which is within the standard allowable range of 0.95 p.u and 1.05 p.u of the nominal voltage value. Whereas voltage measured at the end of distribution feeder lengths of 0.8 km to 5km are less than the permissible voltage range of 0.95 p.u of the nominal voltage, hence, the voltage reaching the end users are not admissible for customer use. The waveforms obtained when DVR controller is introduced to network model is shown in figures 5b to 11b it was observed that DVR effectively improve the voltage profile of the distribution network from the beginning of the distribution feeder lengths of 0.5 km to 5 km to the standard allowable range of 0.95 p.u and 1.05 p.u of the nominal voltage. The simulation results of the DVR are shown in Table 3, while that of without DVR is presented in Table 2. The curve of load voltage profile for both without and with DVR is shown in Figures 12 and 13 respectively. Moreover, it was observed that the DVR inject the required missing voltage needed to compensate the voltage sag experienced in distribution network when DVR is not introduced to the system. This is an indication that the control system design for DVR is suitable seeing that it perform the good purpose for which it is designed in the electric power distribution system.

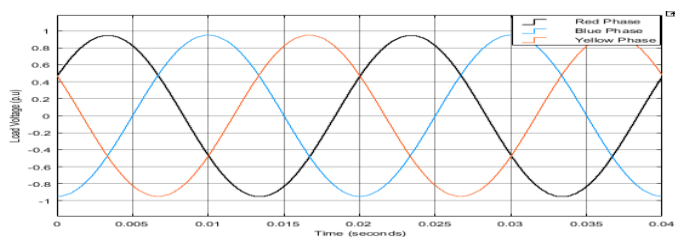

Fig. 5a p.u voltage profile at 0.5 km for 3-phase balanced load without DVR

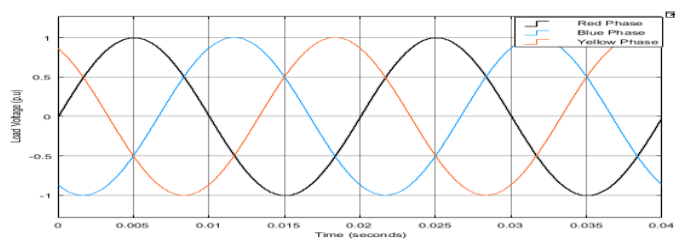

Fig. 5b p.u voltage profile at 0.5 km for 3-phase balanced load with DVR

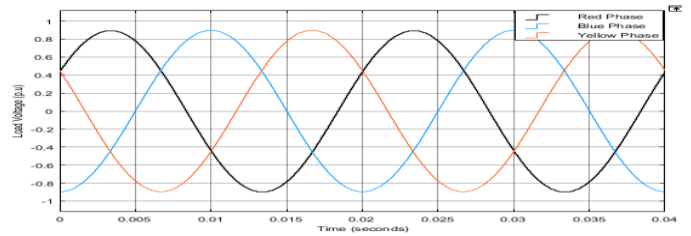

Fig. 6a p.u voltage profile at 0.8 km for 3-phase balanced load without DVR

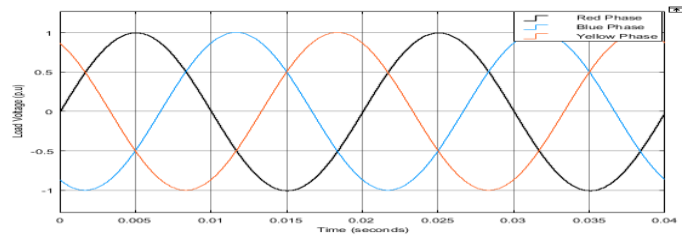

Fig. 6b p.u voltage profile at 0.8 km for 3-phase balance load with DVR

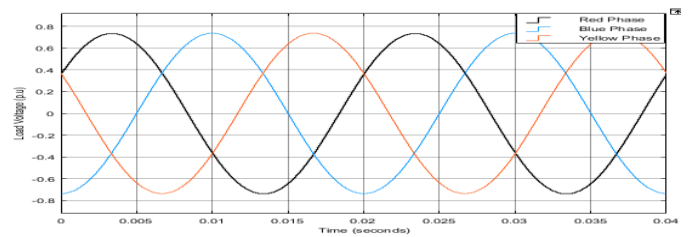

Fig. 7a p.u voltage profile at 1.5 km for 3-phase balanced load without DVR

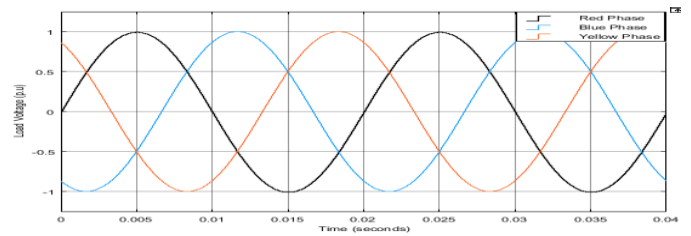

Fig. 7b p.u voltage profile at 1.5 km for 3-phase balanced load with DVR

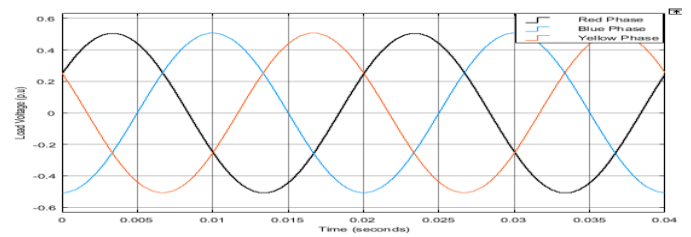

Fig. 8a p.u voltage profile at 2.5 km for 3-phase balanced load without DVR

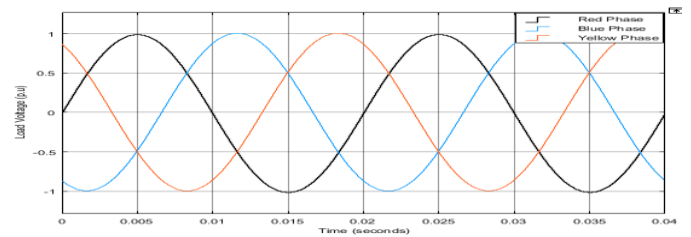

Fig. 8b p.u voltage profile at 2.5 km for 3-phase balanced load with DVR

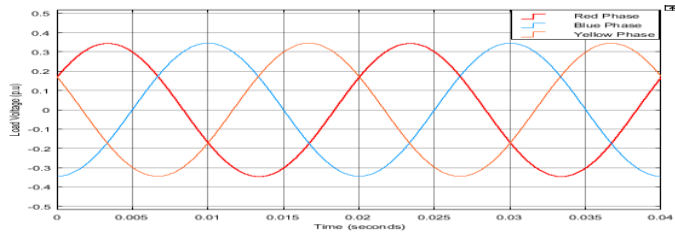

Fig. 9a p.u voltage profile at 3.5 km for 3-phase balanced load without DVR

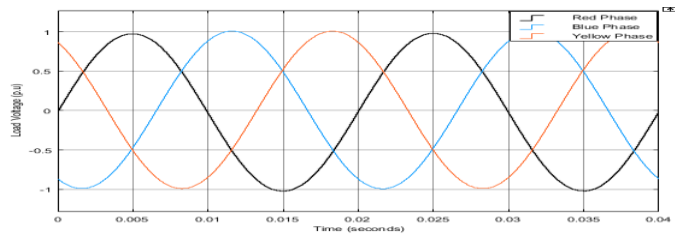

Fig. 9b p.u voltage profile at 3.5 km for 3-phase balanced load with DVR

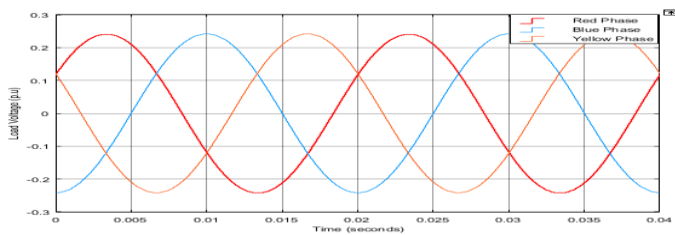

Fig. 10a p.u voltage profile at 4.5 km for 3-phase balanced load without DVR

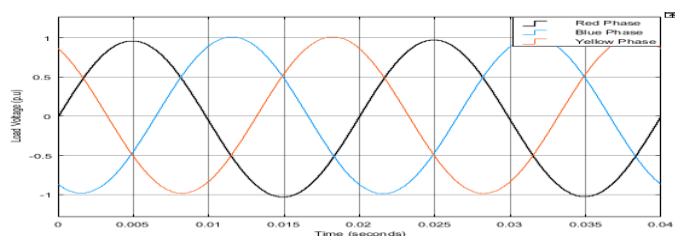

Fig. 10b p.u voltage profile at 4.5 km for 3-phase balanced load with DVR

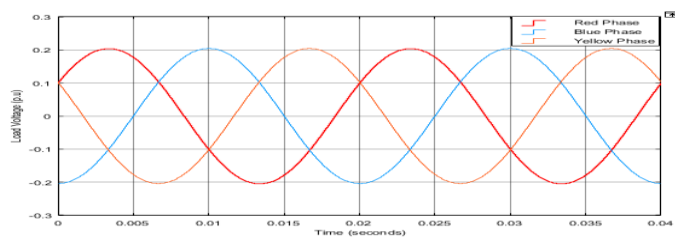

Fig. 11a p.u voltage profile at 5 km for 3-phase balanced load without DVR

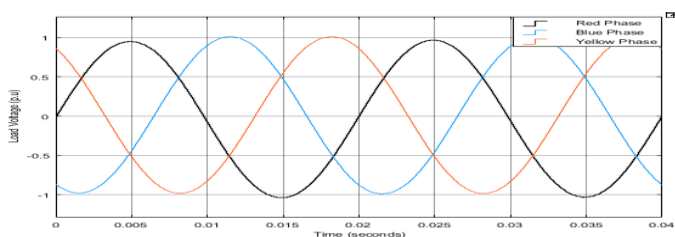

Fig. 11b p.u voltage profile at 5 km for 3-phase balanced load with DVR

TABLE II. PER-UNIT MEASUREMENT OF VOLTAGE PROFILE FOR 3-PHASE BALANCED LOAD WITHOUT DVR

Network length (km)	Load voltage (p.u)
0.5	0.95
0.8	0.90
1.5	0.73
2.5	0.50
3.5	0.34
4.5	0.23
5.0	0.20

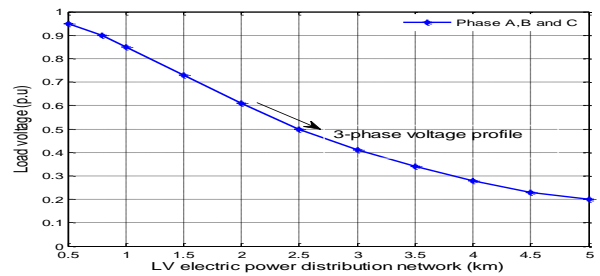

Fig. 12 Curve of voltage profile for 3-phase balanced load without DVR

TABLE III. PER-UNIT MEASUREMENT OF VOLTAGE PROFILE FOR 3-PHASE BALANCED LOAD WITH DVR

Network length, (km)	Load voltage (p.u)
0.5	1.0
0.8	1.0
1.5	1.0
2.5	0.9999
3.5	0.9998
4.5	0.9997
5.0	0.9997

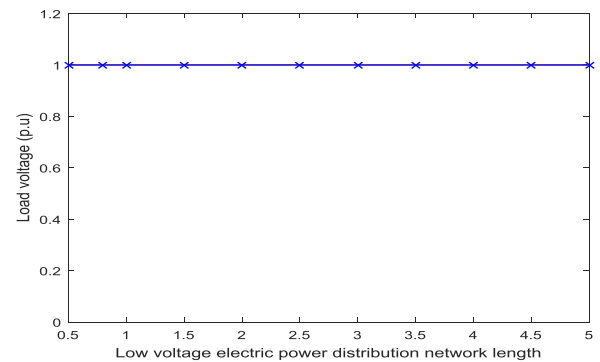

Fig. 13 Curve of voltage profile for 3-phase balanced load with DVR

**A. Simulation results of 3-phase unbalanced load with and without DVR**

The second case presented is simulation of the three phase unbalance load in distribution radial network in the absence of DVR and in the present of DVR. Figures 14a to 20a show the voltage waveforms produced when DVR is absent in the network model, it was observed that at distribution feeder length of 0.5 km at loads of 150 kW on Red phase, 110 kW on Blue phase and 80 kW on Yellow phase the voltage profile reaching the distribution feeder end is within the standard permissible voltage range of  $\pm 5\%$  of nominal voltage value, hence the voltages on the 3-phases are of good quality for end users. While the voltage profile for distribution feeder lengths of 0.8 km to 5 km are less than the minimum standard allowable value of 0.95 p.u of the nominal voltage value, because of this, it is not good for customer use due to the poor voltage quality reaching the customers as stipulated by IEEE standard. Simulation is again carried out in the presence of DVR in 3-phase unbalance load distribution network. It was observed that the voltage waveforms obtained are all within the standard permissible voltage range of 0.95 p.u and 1.05 p.u of nominal voltage value as shown in Figures 14b to 20b. It was noticed that after compensation, the load voltage profile on the 3-phase all returns to its normal 1.0 p.u value. This shows that the control scheme design for DVR is effective and efficient since it serve the purpose for which it is designed. Tables 4 and 5 show the measured load voltage profile for 3-phase unbalanced load without and with DVR respectively. Figures 21 and 22 show the curves of load voltage profile for 3-phase unbalanced load without and with DVR in low voltage electric power distribution network

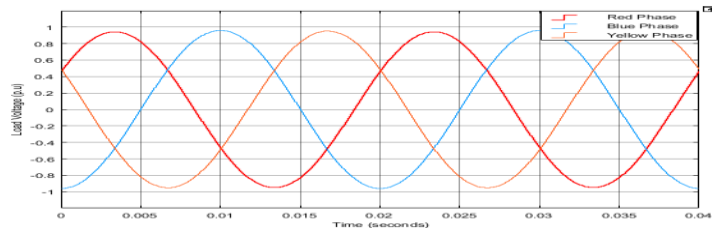

Fig. 14a p.u voltage profile at 0.5 km for 3-phase unbalanced load without DVR

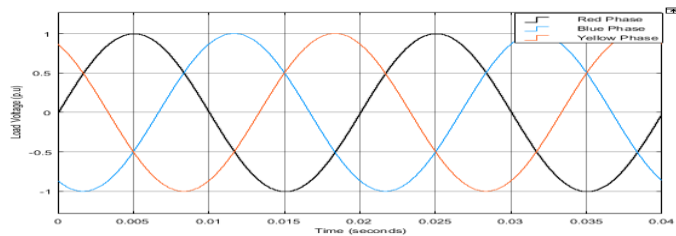

Fig. 14b p.u voltage profile at 0.5 km for 3-phase unbalanced load with DVR

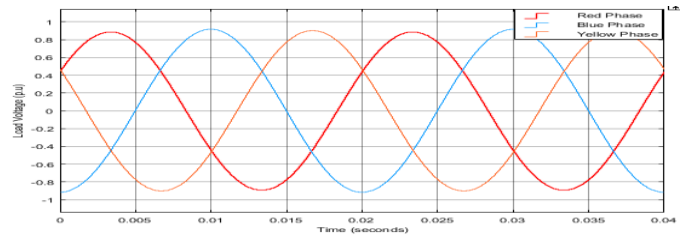

Fig. 15a p.u voltage profile at 0.8 km for 3-phase unbalanced load without DVR

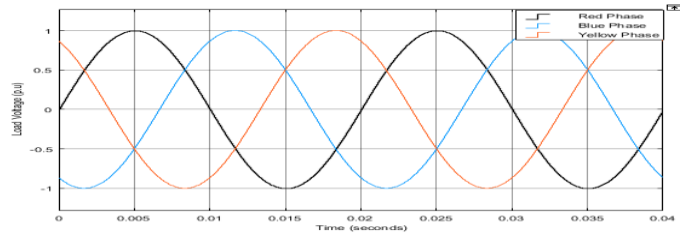

Fig. 15b p.u voltage profile at 0.8 km for 3-phase unbalanced load with DVR

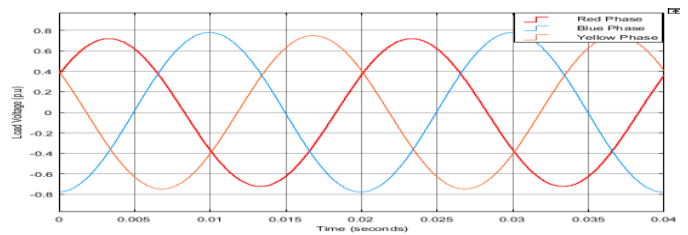

Fig. 16a p.u voltage profile at 1.5 km for 3-phase unbalanced load without DVR

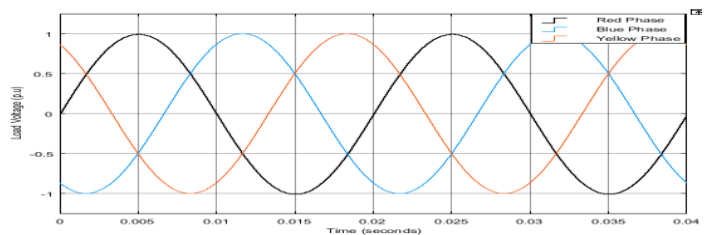

Fig. 16b p.u voltage profile at 1.5 km for 3-phase unbalanced load with DVR

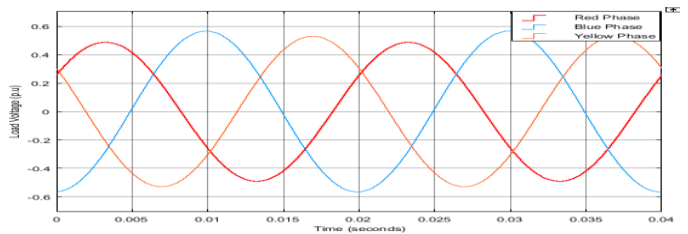

Fig. 17a p.u voltage profile at 2.5 km for 3-phase unbalanced load without DVR

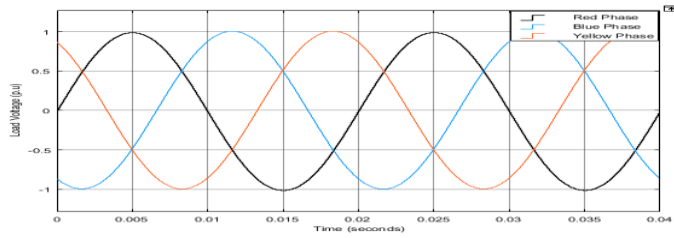

Fig. 17b p.u voltage profile at 2.5 km for 3-phase unbalanced load with DVR

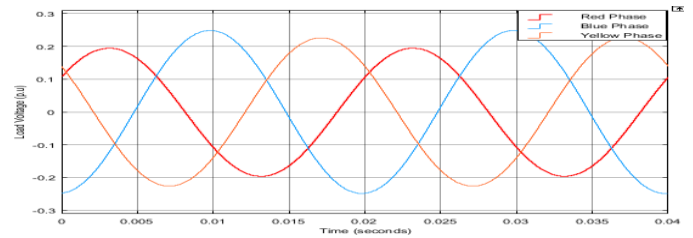

Fig. 20a p.u voltage profile at 5 km for 3-phase unbalanced load without DVR

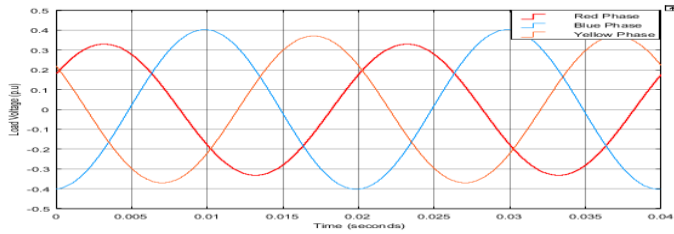

Fig. 18a p.u voltage profile at 3.5 km for 3-phase unbalanced load without DVR

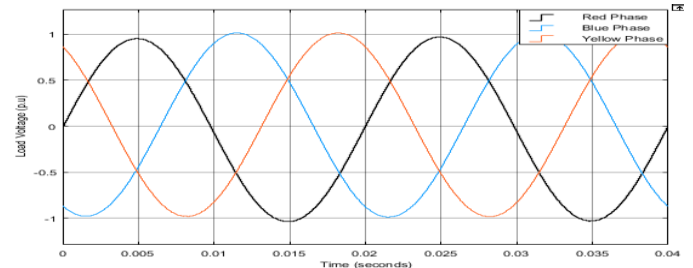

Fig. 20b p.u voltage profile at 5 km for 3-phase unbalanced load with DVR

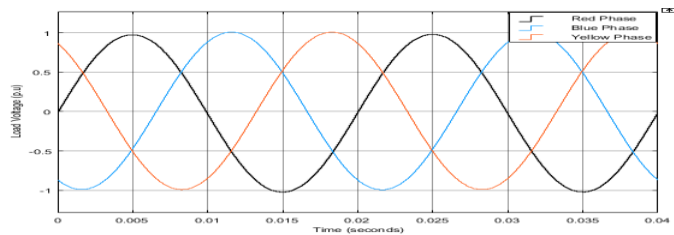

Fig. 18b p.u voltage profile at 3.5 km for 3-phase unbalanced load with DVR

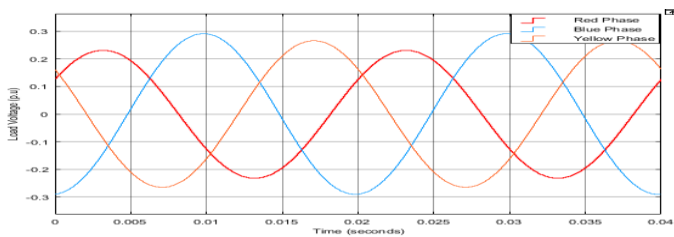

Fig. 19a p.u voltage profile at 4.5 km for 3-phase unbalance load without DVR

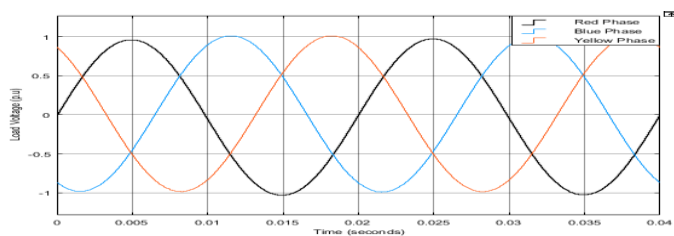

Fig. 19b p.u voltage profile at 4.5 km for 3-phase unbalanced load with DVR

TABLE IV. PER- UNIT MEASUREMENT OF VOLTAGE PROFILE (VP) FOR THREE PHASE UNBALANCED LOAD WITHOUT DVR

L, (km)	P.u VP, 150 kW	P.u VP, 110 kW	P.u VP, 80 kW
0.5	0.94	0.95	0.97
0.8	0.87	0.90	0.93
1.5	0.68	0.75	0.80
2.5	0.45	0.52	0.60
3.5	0.29	0.36	0.44
4.5	0.21	0.25	0.32
5.0	0.17	0.22	0.28

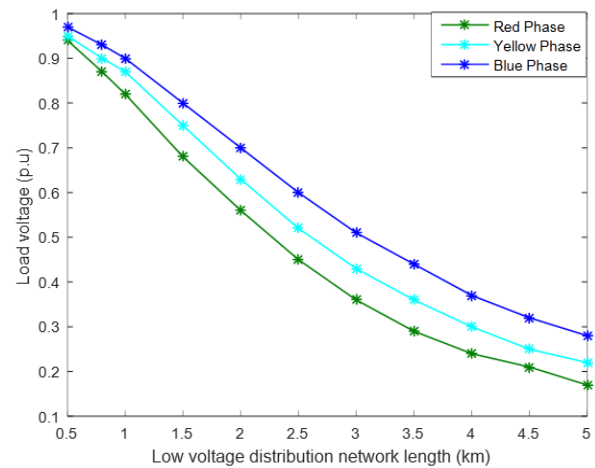

Fig. 21 Curve of voltage profile for 3-phase unbalanced load without DVR



TABLE V. PER-UNIT MEASUREMENT OF VOLTAGE PROFILE FOR 3-PHASE UNBALANCED LOAD WITH DVR

L, (km)	P.u VP, 150 kW	P.u VP, 110 kW	P.u VP, 80 Kw
0.5	1	1	1
0.8	1	1	1
1.5	1	1	1
2.5	0.9999	0.9999	0.9999
3.5	0.9998	0.9998	0.9998
4.5	0.9997	0.9997	0.9997
5.0	0.9997	0.9997	0.9997

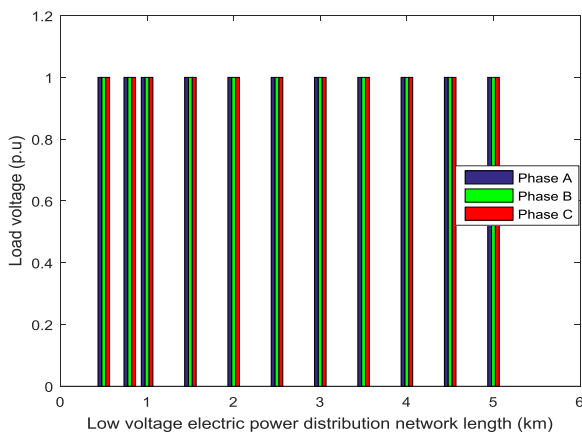

Fig. 22 Curve of voltage profile for 3 -phase unbalanced load with DVR

## CONCLUSIONS

This paper presented the use of DVR for voltage unbalanced correction and voltage profile improvement using MATLAB/Simulink Sim Power System tool box. The simulation results validate the proposed operation scheme for the detection and control of the DVR. It is obvious the simulation results shown that the DVR compensation is quick and rapid and the source voltage unbalanced can be compensated by series injection voltage transformer. It was observed that the effectiveness of DVR in voltage profile enhancement and unbalanced voltage correction depends solely on the rating of the DC storage device and the defining features of the boosting transformer. The stated two factors influence the extent value of voltage unbalanced and voltage profile compensation the DVR can perform.

## ACKNOWLEDGMENT

This research has been supported by Eskom Power Plant Engineering Institute (EPPEI), South Africa.

## REFERENCES

[1] IEEE recommended practice for electric power distribution for industrial plants. IEEE Standard 141, 1993

[2] IEEE recommended practice for monitoring electric power quality. IEEE Standard 1195; 2009.

[3] PS. Babu, N. Kamaraj, "Performance investigation of dynamic voltage restorer using PI and fuzzy controller," Int Conf on Power, Energy and Control, Sri, Rangalatchum, Dindigul, IEEE, pp. 467-72, 2013.

[4] P. T. Ogunboyo, R. Tiako, IE Davidson, IE, "Application of Dynamic Voltage Restorer for Power Quality Improvement in Low Voltage Electrical Power Distribution Network: An Overview," *International Journal of Engineering Research in Africa*, Vol. 28, pp. 142-156, 2017.

[5] F. A. L. Jowder, "Design and analysis of dynamic voltage restorer for deep voltage sag and harmonic compensation," *Generation, Transmission & Distribution*, vol. 3, pp. 547-560, 2009.

[6] S. Abdul Rahman, P. A. Janakiraman, P. Somasundaram, "Voltage sag and swell mitigation based on modulated carrier PWM," *Int J Electr Power Energy System*, vol. 66, pp. 78-85, 2015.

[7] S. Hazarika, S. S Roy, R. Baishya, S. Dey, "Application of Dynamic Voltage Restorer in electrical distribution system for voltage sag compensation," *The International Journal of Engineering and Science (IJES)*, vol. 2, Issue 7, pp. 30-38, 2013.

[8] M. Ahmed, Saeed et al., "Power conditioning using dynamic voltage restorers under different voltage sag types," *Journal of Advanced Research*, vol. 7, pp. 95-103, 2016.

[9] B. Parmar, S. Shivani, C. Chodavadiya, "Improvement of voltage profile using DSTATCOM simulation under sag and swell condition," *International Journal of Innovative and Research in Electrical, Electronics, Instrumentation and Control Engineering*, vol. 2, Issue 7, 2014.

[10] R. Omar, N. R. Rahim, "Voltage unbalanced compensation using dynamic voltage restorer based on supercapacitor," *Journal of Electrical Power and Energy Systems*, vol. 44, pp. 573-581, 2012.

[11] P. T Ogunboyo, R. Taiko, I. E. Davidson, "An Improvement of Voltage Unbalance in a Low Voltage 11/0.4 kV Electric Power distribution Network under 3-phase Unbalance Load Condition using Dynamic Voltage Restorer," *IEEE PES-IAS PowerAfrica, International Conference, GIMPA, Accra-Ghana, 27-30 June*, pp 126-131, 2017

[12] A. Suresh, U. Govindaraj, "Power quality improvement using a dual voltage source converter based DVR," *International Journal of Engineering Trends and Technology (IJETT)*, vol. 7, no. 4, pp. 160-164, 2014.

[13] S. Farhard, A. Ghosh, G. Ledwish, F. Zare, "Voltage unbalance improvement in low residential feeder with rooftop PVs using custom power devices," *Electrical Power and Energy Systems*, vol. 55, pp. 362-377, 2014.